

## II. PRÍSTROJOVÉ KOLESÁ ROLLEN FÜR APPARATE - APPARATUS CASTORS

### Samostatné kolesá - séria CNA /nosnosť 20-35kg/









1

Kolesá z polypropylénu, klzné uloženie /K/

Radkörper aus Polypropylene mit Gleitlager /K/

Polypropylene wheel with plain bearing /K/

Samostatné koleso Rad Wheel						 kg
CNA-K025-14/4 š	025	14	=	4,1	15,5	20
CNA-K040-18/6 š	040	18	=	6,1	21,2	35
CNA-K050-17/6 š	050	17	=	6,1	20,5	35

Kolesá s klzným uložením

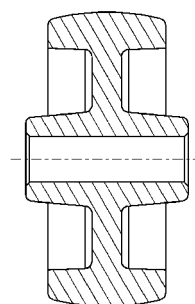

=

Označenie: CNA-K...

## Prístrojové kolesá série 241,241B s kolesami CNA /nosnosť 35kg/

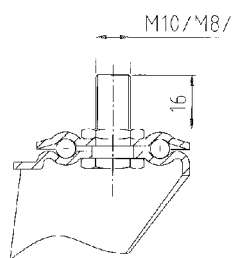

Otočná vidlica z oceleového plechu, pozinkovaná, s jednoduchým guľičkovým vekom v smerovej otoči, os kolesa zaistená skrutkou









Gehäuse aus Stahlblech, verzinkt-chromatisiert, mit einreihigem Kugelkranz im Gabelkopf

Housing made of pressed steel, zinc-chromatised, single ball bearing swivel head

Upeňovací trň na otočné vidlice série 241











2

Otočné koleso Lenkrolle Swivel castor								
241 CNA-K040 š T1	040	18	=	8	14	23	62	35
241 CNA-K050 š T1	050	17	=	8	14	23	67	35



3

Otočné koleso s brzdou kolesa Rad-feststeller Wheel brake								
241B CNA-K040 š T1	040	18	=	8	14	23	62	35
241B CNA-K050 š T1*	050	17	=	8	14	23	67	35

\* Zahájenie výroby a predaja: december 2005

## Prístrojové kolesá série 221,221B,231 s kolesami CNA /nosnosť 20-35kg/

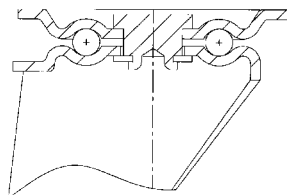
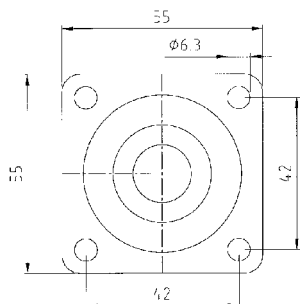

Otočná vidlica z oceleového plechu, pozinkovaná, s jednoduchým guľičkovým vekom v smerovej otoči, os kolesa zaistená skrutkou.









Gehäuse aus Stahlblech, verzinkt-chromatisiert, mit einreihigem Kugelkranz im Gabelkopf

Housing made of pressed steel, zinc-chromatised ball bearing swivel head.

Upevňovacia príruha štvorhranná typ P1  
na vidlice série 221,231











4

Otočné koleso Lenkrolle Swivel castor									
221 CNA-K040 š	040	18	=	55x55	42x42	6,3	23	59	35
221 CNA-K050 š	050	17	=	55x55	42x42	6,3	23	64	35





5

Pevné koleso Bockrolle Fixed castor									
231 CNA-K040 š	040	18	=	55x55	42x42	6,3	-	59	35
231 CNA-K050 š	050	17	=	55x55	42x42	6,3	-	64	35











6

Otočné koleso s brzdou kolesa Rad-feststeller Wheel brake									
221B CNA-K040 š	040	18	=	55x55	42x42	6,3	23	59	35
221B CNA-K050 š	050	17	=	55x55	42x42	6,3	23	64	35



7

Pevné koleso Bockrolle Fixed castor									
231 CNA-K025 š	025	14	=	45x19	35	-	-	28	20

## Samostatné kolesá -séria CPA

/nosnosť 35-50kg/









8

Koleso z polyamidu, klzné uloženie /K/

Radkörper aus Polyamid mit Gleitlager /K/

Polyamide wheel with plain bearing /K/

Samostatné koleso Rad Wheel						
CPA-K050-17/8 č	050	17	=	8,2	20,5	35
CPA-K050-22/8 č	050	22	=	8,2	28,0	50

Kolesá s klzným ułożením

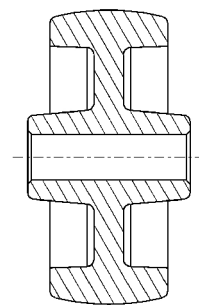

=

Označenie: CPA-K...

## Prístrojové kolesá série 252,252B,254,254B s kolesami CPA

/nosnosť 50-70 kg/

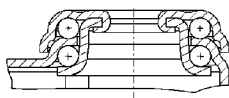
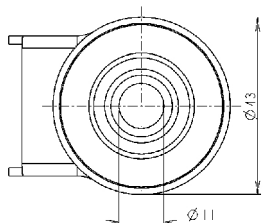

Otočná vidlica lisovaná z oceľového plechu, pozinkovaná, s dvojitým guľíkovým vencom v smerovej otoči, os kolesa zaistená skrutkou

Gehäuse aus Stahlblech, verzinkt-chromatisiert, mit zweireihigem Kugelkranz im Gabelkopf







Housing made of pressed steel zinc-chromatised, double ball bearing swivel head

Upevnenie na stredový otvor  $\varnothing 11$   
na otočné vidlice série 252,254

Otočná vidlica typ 252,254









9

Otočné koleso Lenkrolle Swivel castor							
252 CPA-K050 č	050	22	=	11	20	70	50









10

Otočné koleso s brzdou kolesa Rad-feststeller Wheel brake							
252B CPA-K050 č	050	22	=	11	20	70	50









11

Otočné koleso Lenkrolle Swivel castor							
254 CPA-K050 č	050	2x17	=	11	27	66	70



12

Otočné koleso s brzdou kolesa Rad-feststeller Wheel brake							
254B CPA-K050 č	050	2x17	=	11	27	66	70

## Prístrojové kolesá série 222, 222B, 232, 224, 224B s kolesami CPA

/nosnosť 50-70 kg/

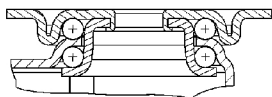
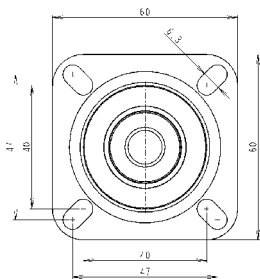

Otočná vidlica lisovaná z oceľového plechu, pozinkovaná, s dvojitým guľíkovým vencom v smerovej otoči, os kolesa zaistená skrutkou

Gehäuse aus Stahlblech, verzinkt-chromatisiert, mit zweireihigem Kugelkranz im Gabelkopf

Housing made of pressed steel zinc- chromatised, double ball bearing swivel head

Upevňovacia príruha štvorhranná - typ P2 na vidlice série 222, 232, 224

Otočná vidlica typ 222,224



13

Otočné koleso Lenkrolle Swivel castor									
222 CPA-K050 č	050	22	=	60x60	47/40x47/40	6,3	32	70	50



14

Pevné koleso Bockrolle Fixed castor									
232 CPA-K050 č	050	22	=	60x60	47/40x47/40	6,3	-	70	50



15

Otočné koleso s brzdou kolesa Rad-feststeller Wheel brake									
222B CPA-K050 č	050	22	=	60x60	47/40x47/40	6,3	32	70	50



16

Otočné koleso Lenkrolle Swivel castor									
224 CPA-K050 č	050	2x17	=	60x60	47/40x47/40	6,3	32	66	70



17

Otočné koleso s brzdou kolesa Rad-feststeller Wheel brake									
224B CPA-K050 č	050	2x17	=	60x60	47/40x47/40	6,3	32	66	70

## Samostatné kolesá - séria NOA

/nosnosť 55-75 kg/

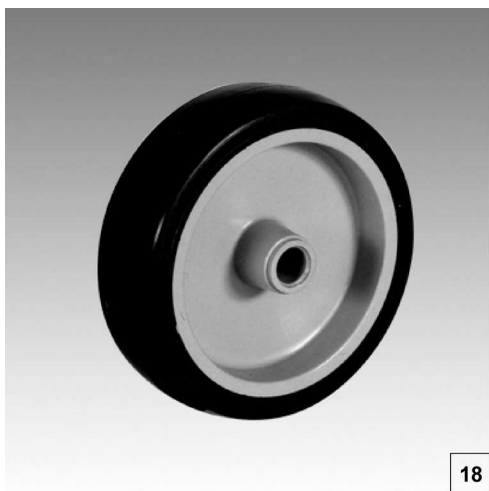







18

Koleso z polypropylénu, klzné uloženie /K/, behúň - termoplastická gumová obrúč šedej farby /Shore A95/

Radkörper aus Polypropylene mit Thermoplastische-gummireifen, Gummiqualiteten: blau grau, /Shore A95/, Gleitlager /K/

Wheel centre of polypropylene, with solid thermoplastic rubber tyre, rubber quality: blue -grey, /Shore A95/, with plain bearing /K/

Samostatné koleso Rad Wheel						 kg
NOA-K050	050	22	=	8,2	29	55
NOA-K075	075	22	=	8,2	29	75

Kolesá s klzným uložením

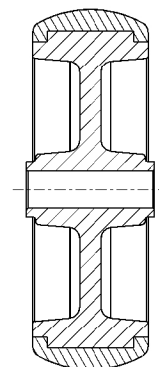

=

Označenie: NOA - K...

## Prístrojové kolesá série 252, 252B s kolesami NOA /nosnosť 55-75 kg/

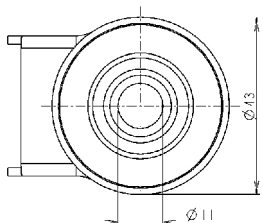

Upevnenie na stredový otvor Ø 11  
na otočné vidlice série 252

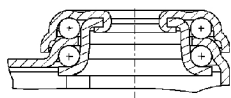

Otočná vidlica typ 252







Otočná vidlica lisovaná z oceľového plechu ,pozinkovaná ,s dvojitým guľčkovým vencom v smerovej otoči, os kolesa zaistená skrutkou

Gehäuse aus Stahlblech, verzinkt-chromatisiert, mit zweireihigem Kugelkranz im Gabelkopf

Housing made of pressed steel zinc-chromatised, double ball bearing swivel









20

Otočné koleso Lenkrolle Swivel castor							
252 NOA-K050	050	22	=	11	24	28	55
252 NOA-K075	075	22	=	11	24	98	75



21

Otočné koleso s brzdou kolesa Rad-feststeller Wheel brake							
252B NOA-K050	050	22	=	11	24	28	55
252B NOA-K075	075	22	=	11	24	98	75